

0 601 347 066

Issue } 00-03-20 **Fig./Abb. 1**  
Stand }

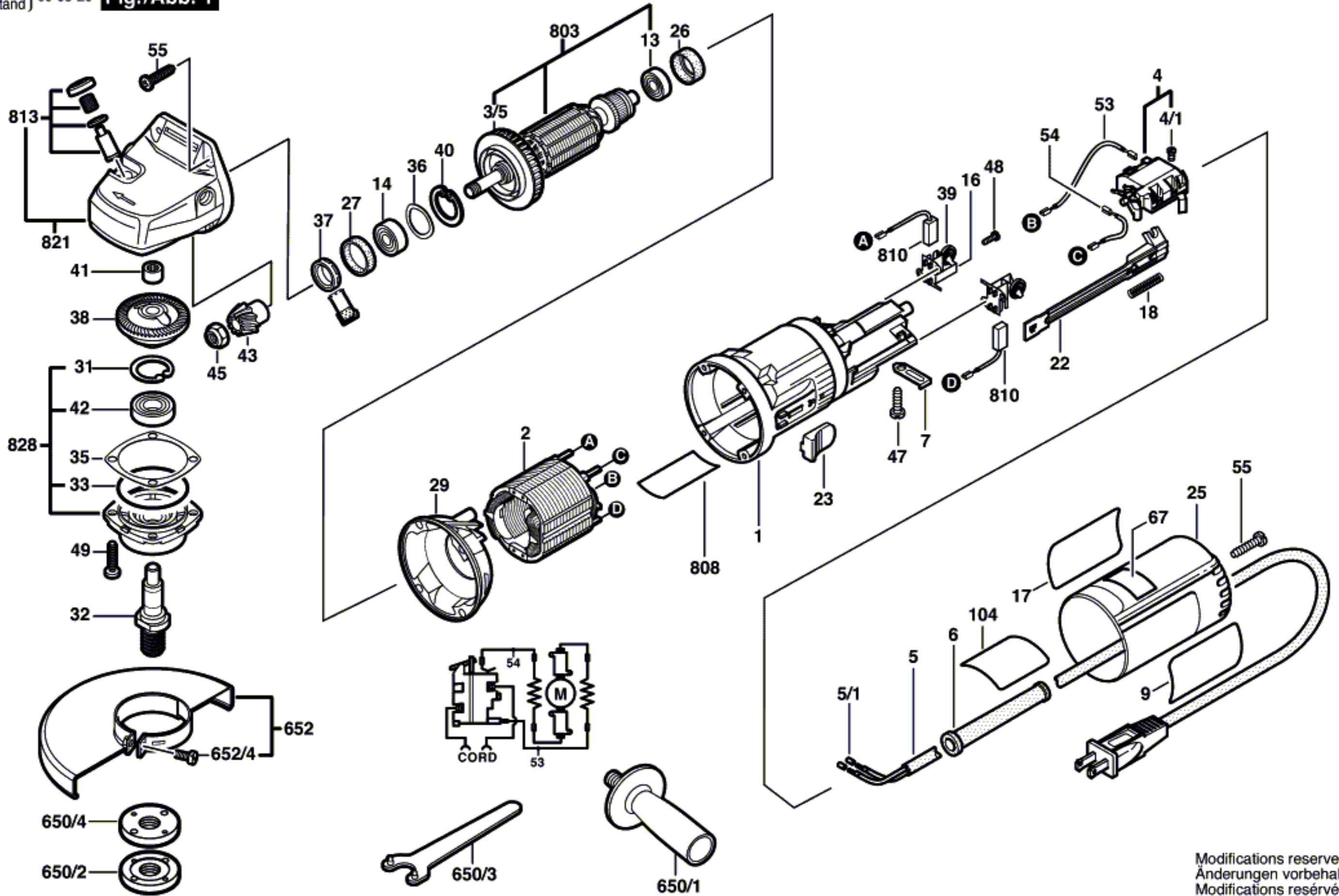

Modifications reserved  
Änderungen vorbehalten  
Modifications réservées  
Salvo modificaciones