

0 601 913 260

Stand } 04-12
Issue } 05-03-23

Fig./Abb. 1

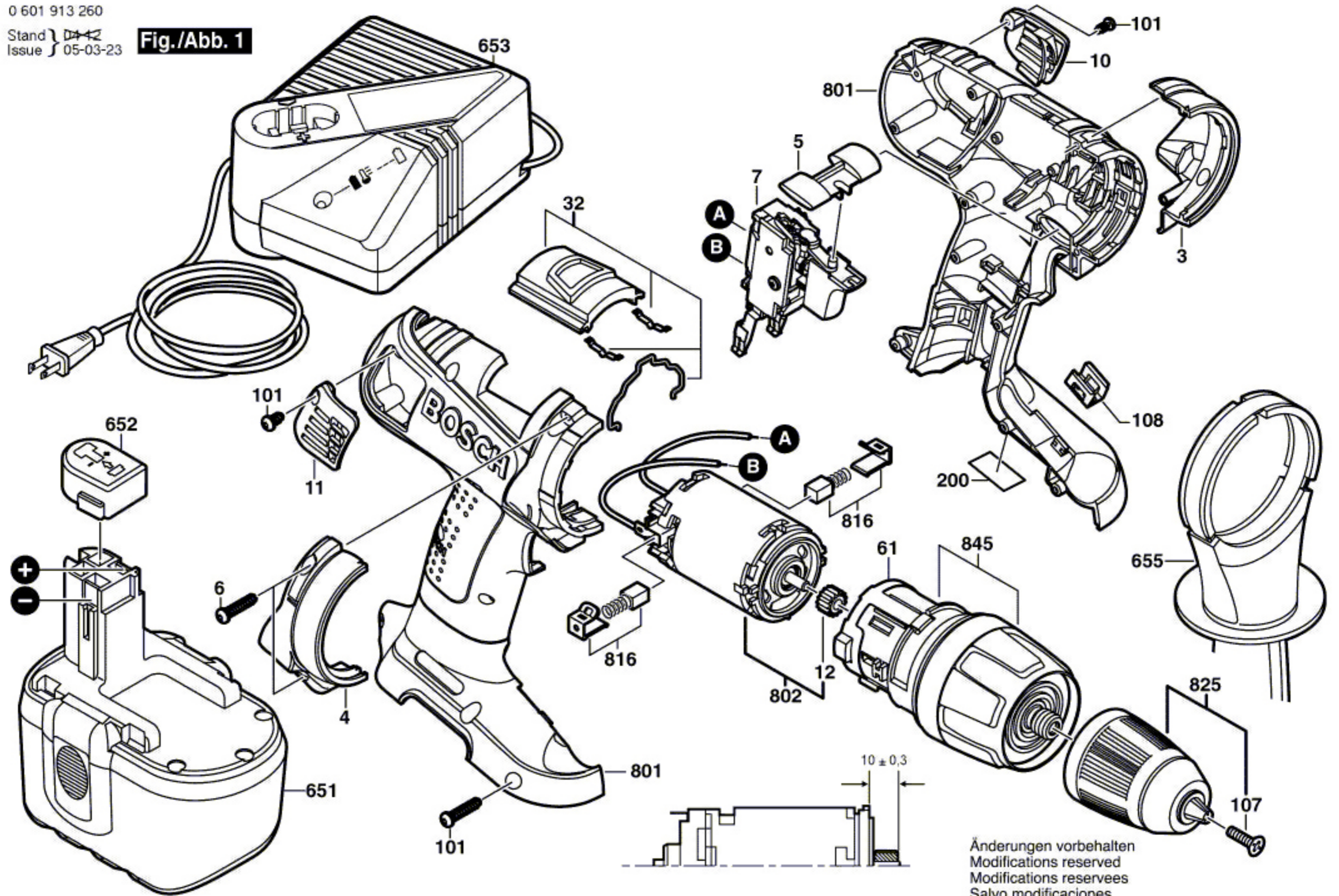

Änderungen vorbehalten
Modifications reserved
Modificaciones reservadas
Salvo modificaciones