

0 601 656 139
Issue }
Stand } 03-01-21

Fig./Abb. 1

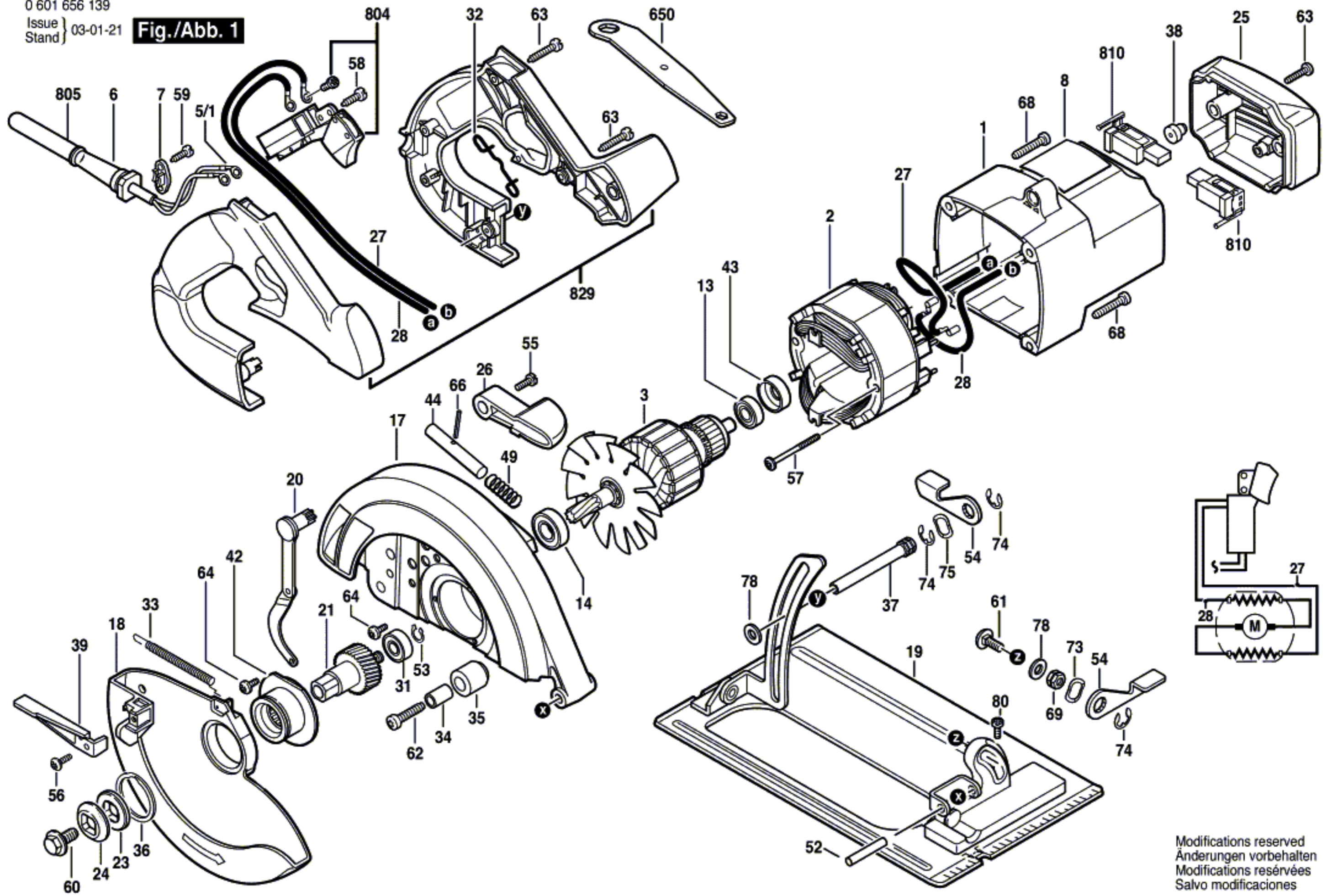

Modifications reserved
Änderungen vorbehalten
Modifications réservées
Salvo modificaciones