

0 601 657 039

Issue } 00-05-30
Stand }

Fig./Abb. 1

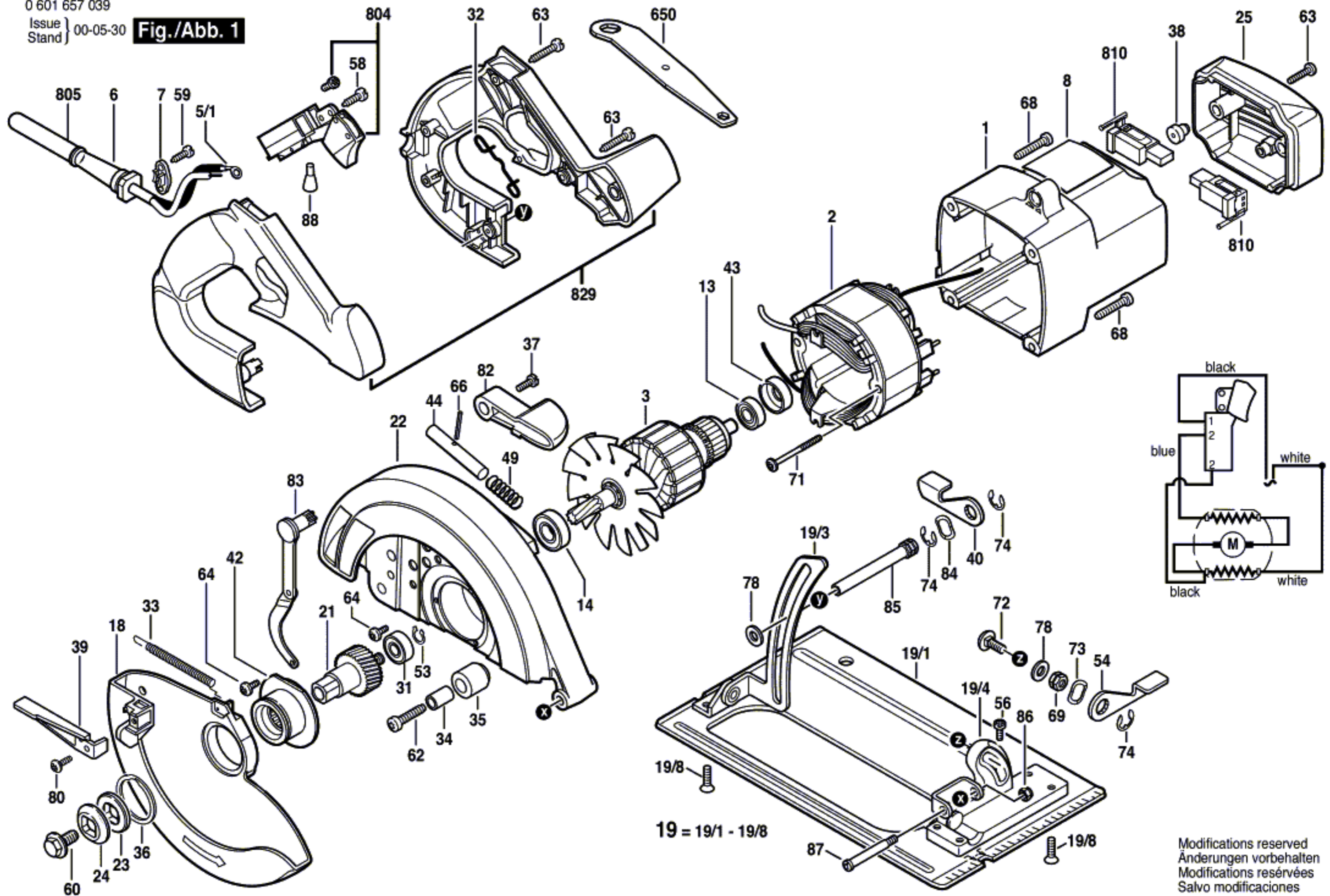

19 = 19/1 - 19/8

Modifications reserved
Änderungen vorbehalten
Modifications réservées
Salvo modificaciones