

0 601 659 339

Issue } 02-04-25  
Stand }

**Fig./Abb. 1**

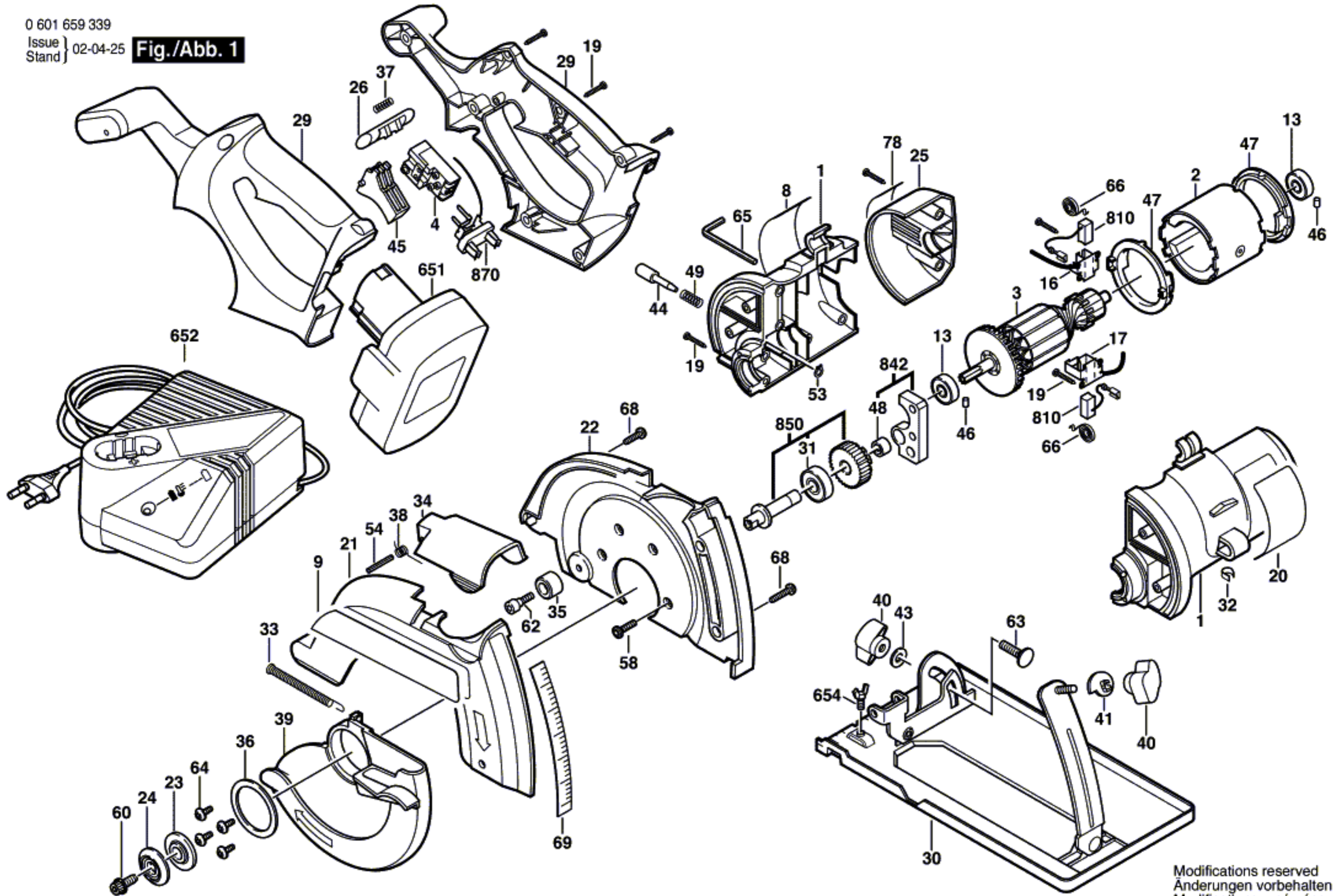

Modifications reserved  
Änderungen vorbehalten  
Modifications réservées  
Salvo modificaciones