

F 012 286 600

Stand } 04-10-20
Issue } 04-10-20

Fig./Abb. 1

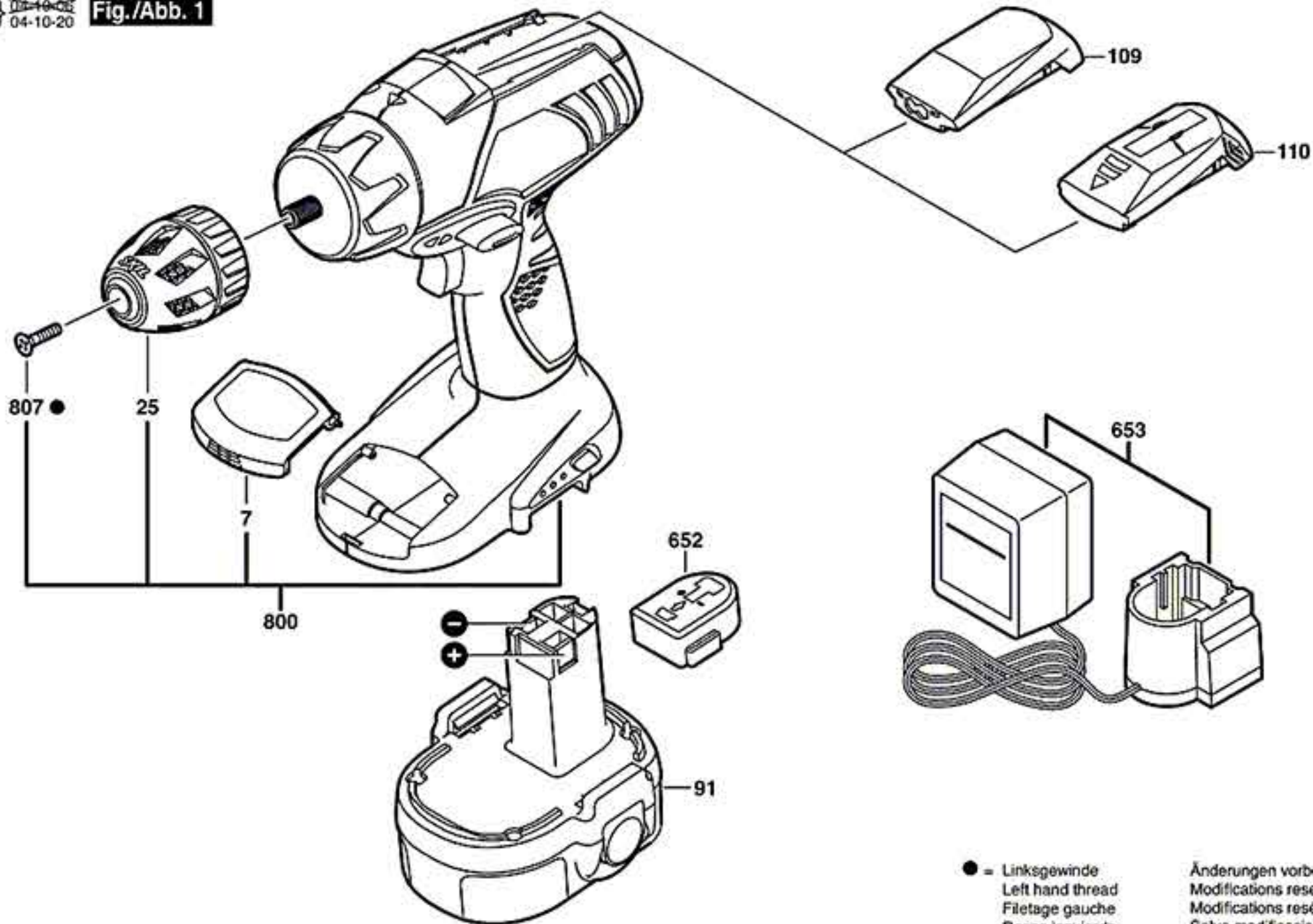

● = Linksgewinde
Left hand thread
Filetage gauche
Rosca izquierda

Änderungen vorbehalten
Modifications reserved
Modifications réservées
Salvo modificaciones