

0 601 372 439

Stand } 11-05-26
Issue } 11-07-25

Fig. /Abb. 1

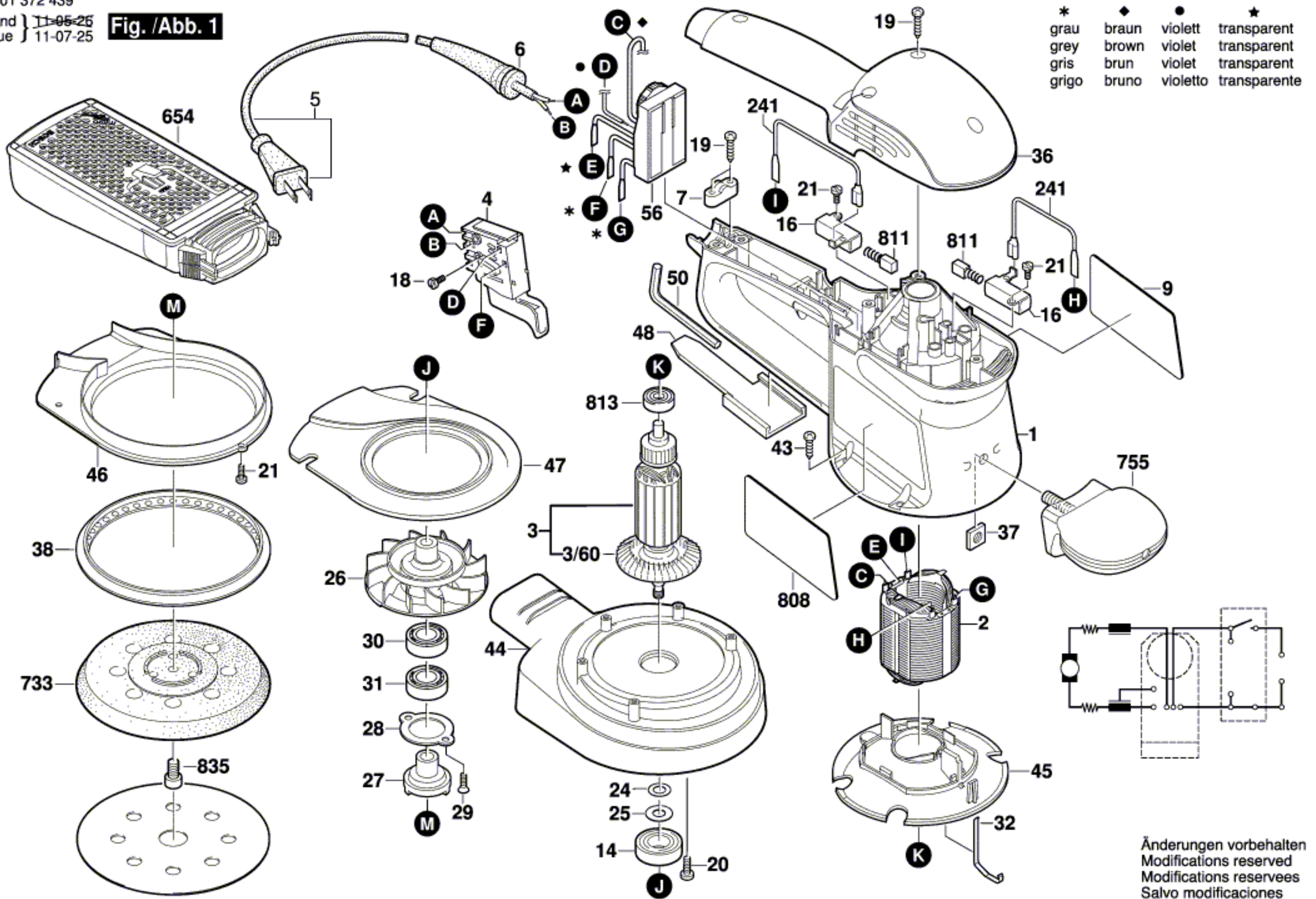

Änderungen vorbehalten
Modifications reserved
Modifications reserves
Salvo modificaciones