

0 607 561 101; 105

Issue } 05-01-17 **Fig./Abb. 1**
Stand }

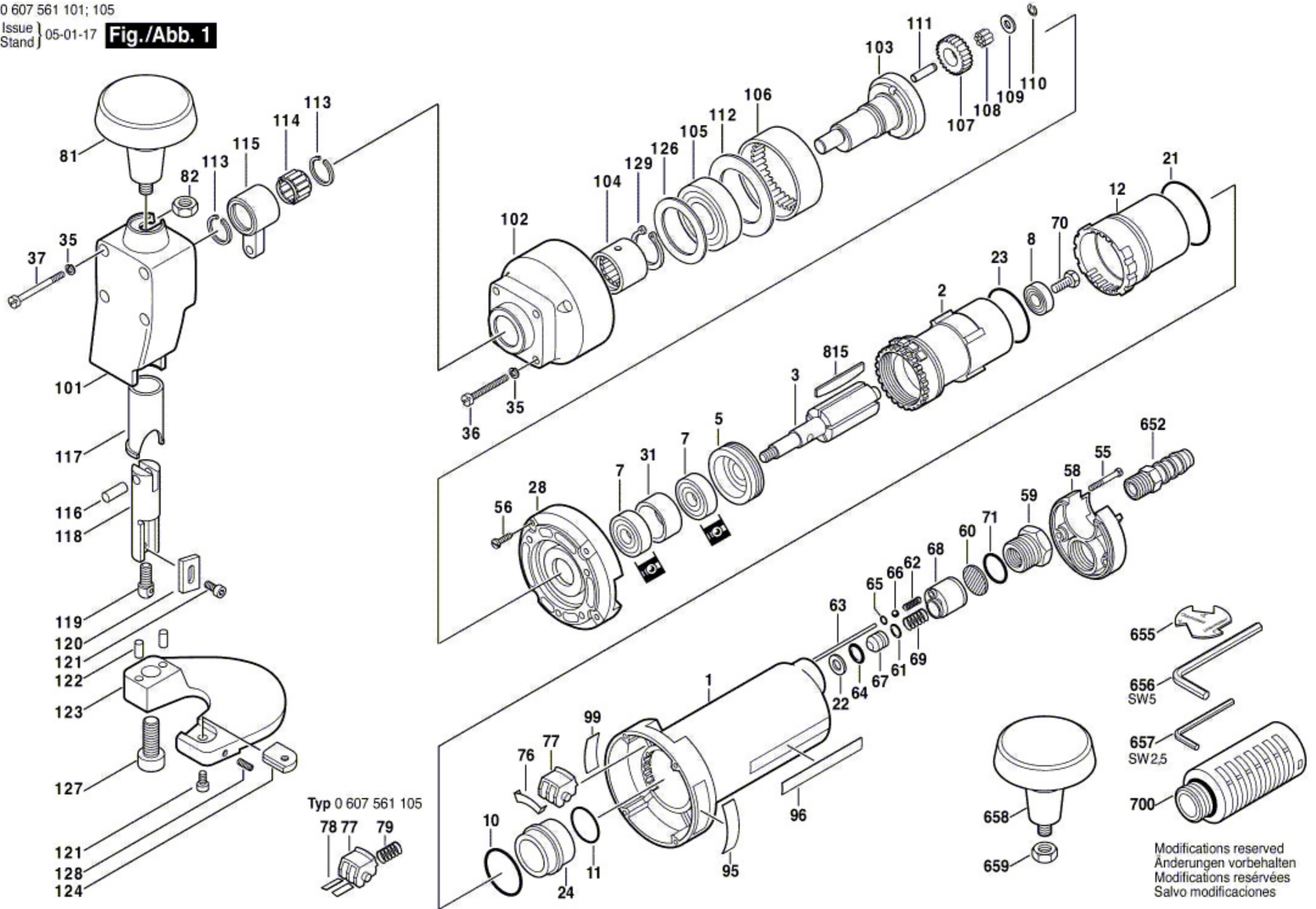

Modifications reserved
Änderungen vorbehalten
Modifications réservées
Salvo modificaciones