

0 607 561 102; 106

Issue } 05-01-17 **Fig./Abb. 1**  
Stand }

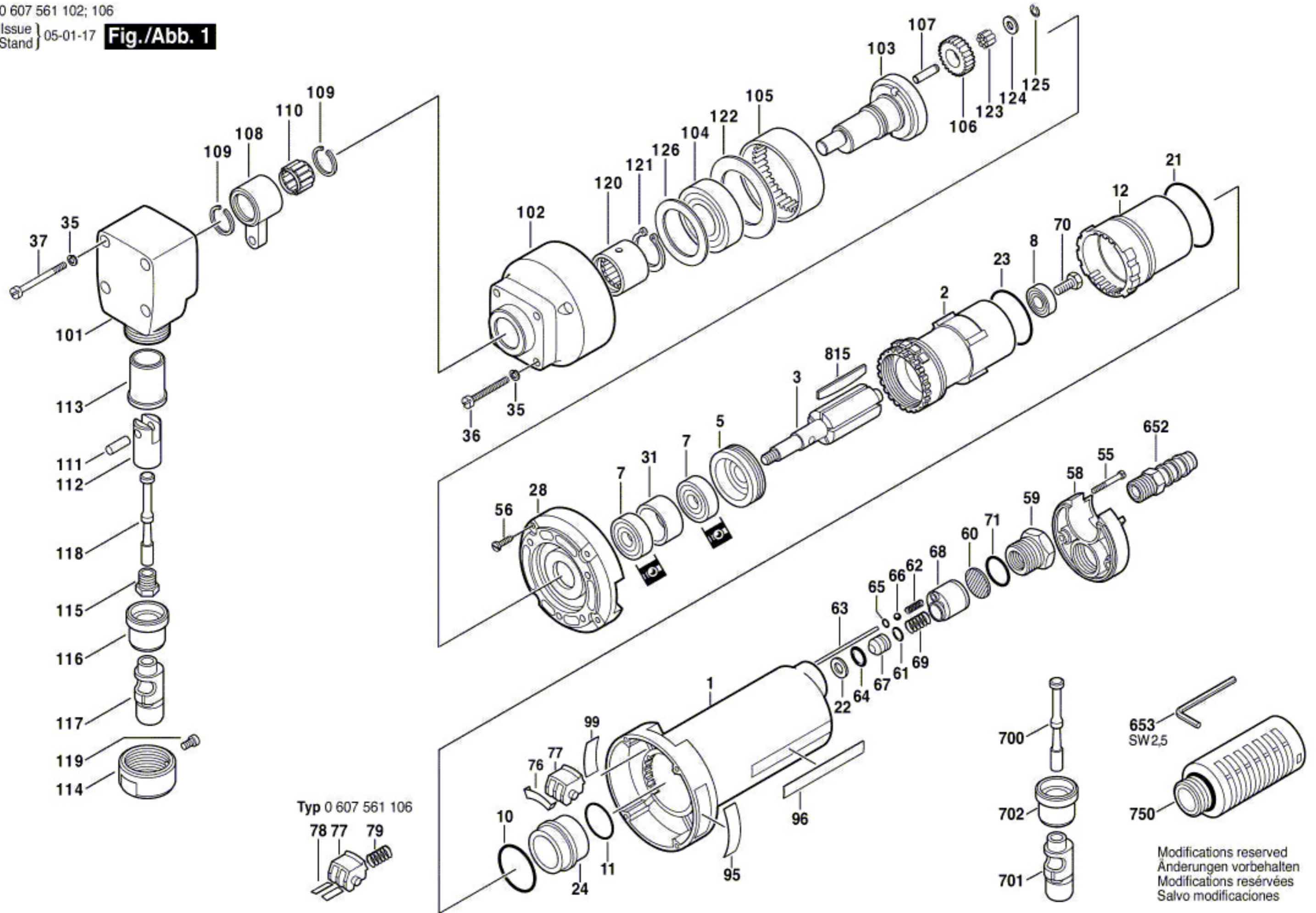

Modifications reserved  
Änderungen vorbehalten  
Modifications réservées  
Salvo modificaciones