

F012 447 000

Issue Stand 00-11-21 **Fig./Abb. 1**

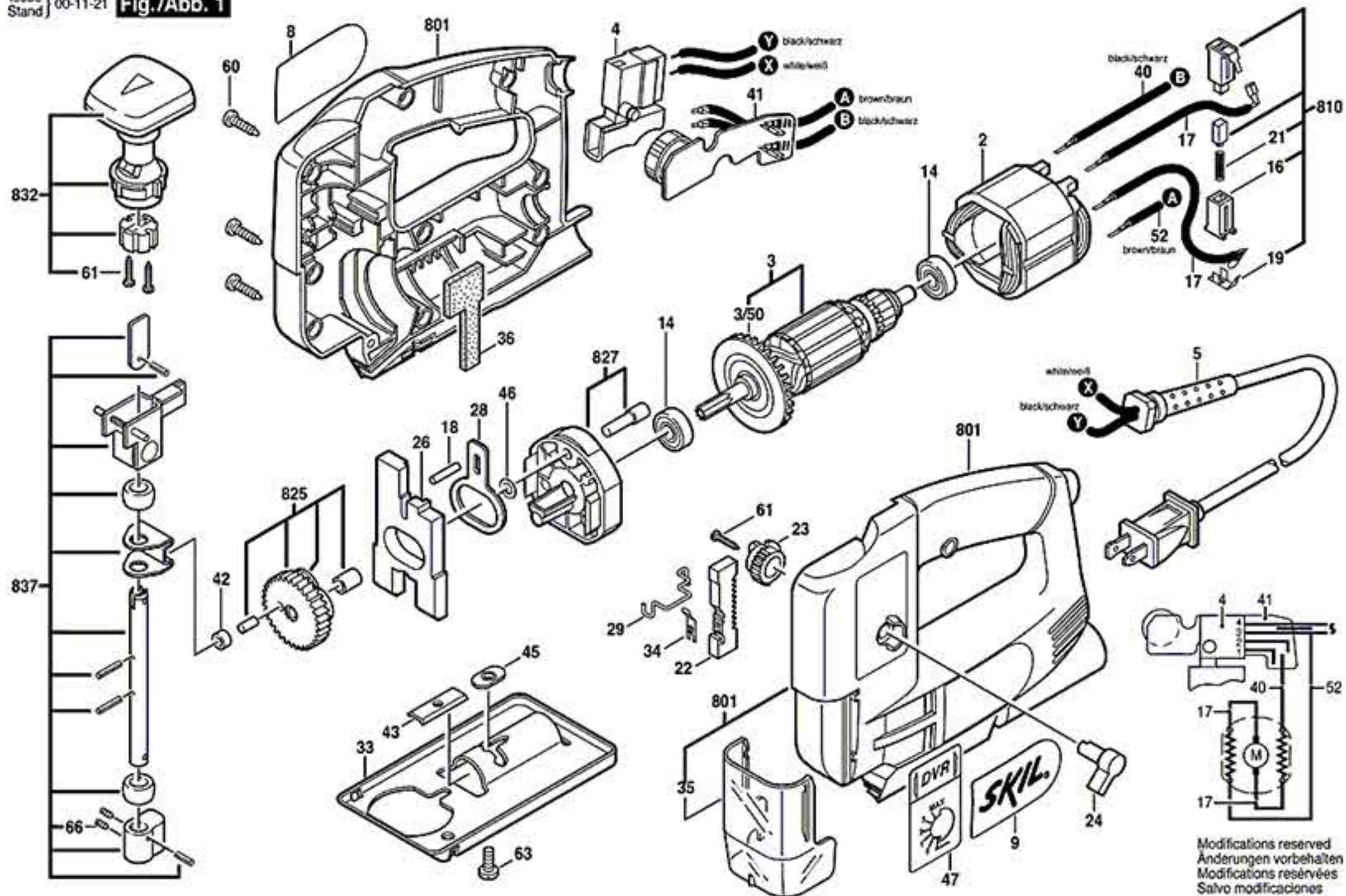

Modifications reserved
Änderungen vorbehalten
Modifications réservées
Salvo modificaciones