

F012 454 000

Issue } 02-12-10  
Stand }

**Fig./Abb. 1**

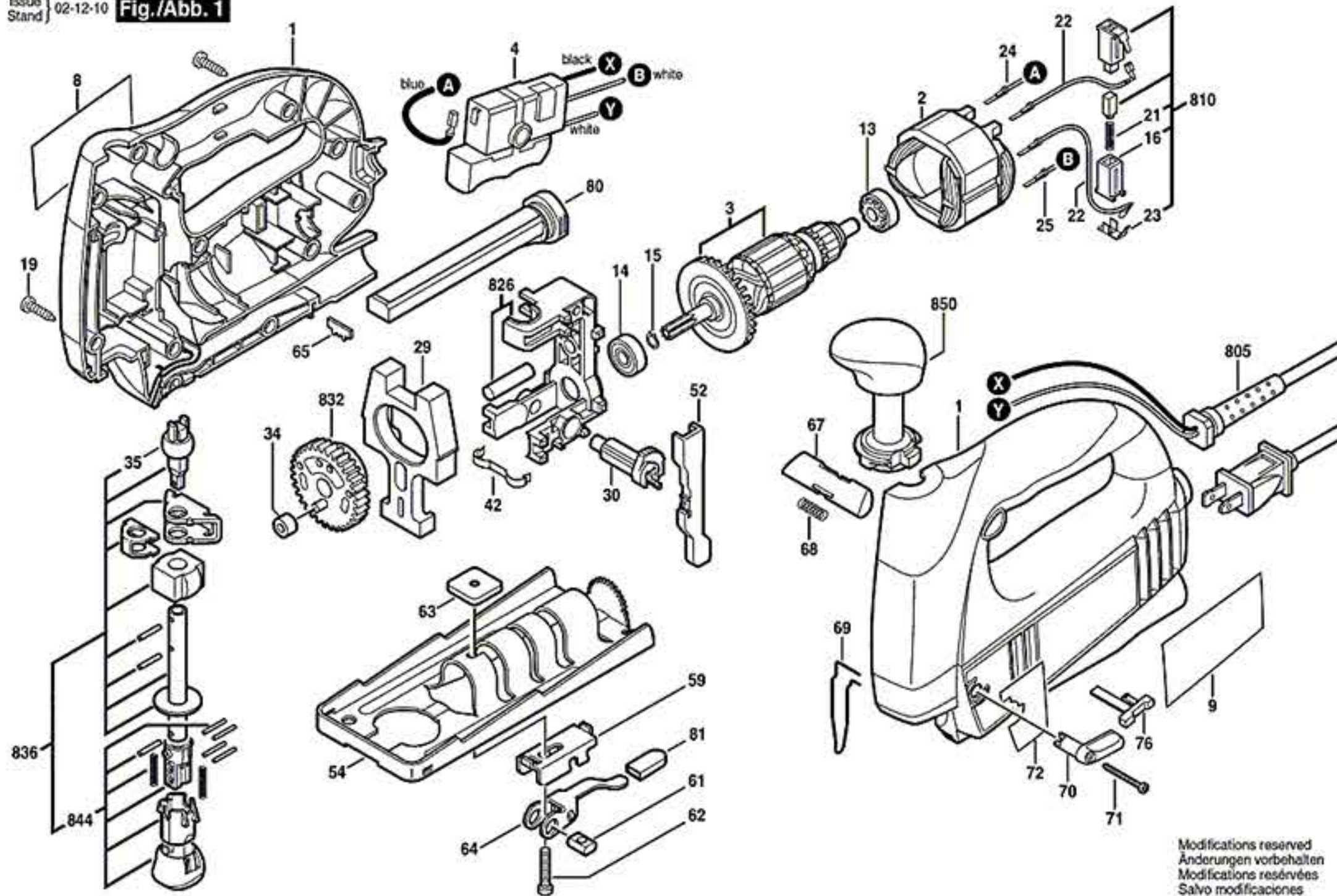

Modifications reserved  
Änderungen vorbehalten  
Modifications réservées  
Salvo modificaciones