

F012 566 099

Issue } 00-12-18  
Stand }

**Fig./Abb. 1**

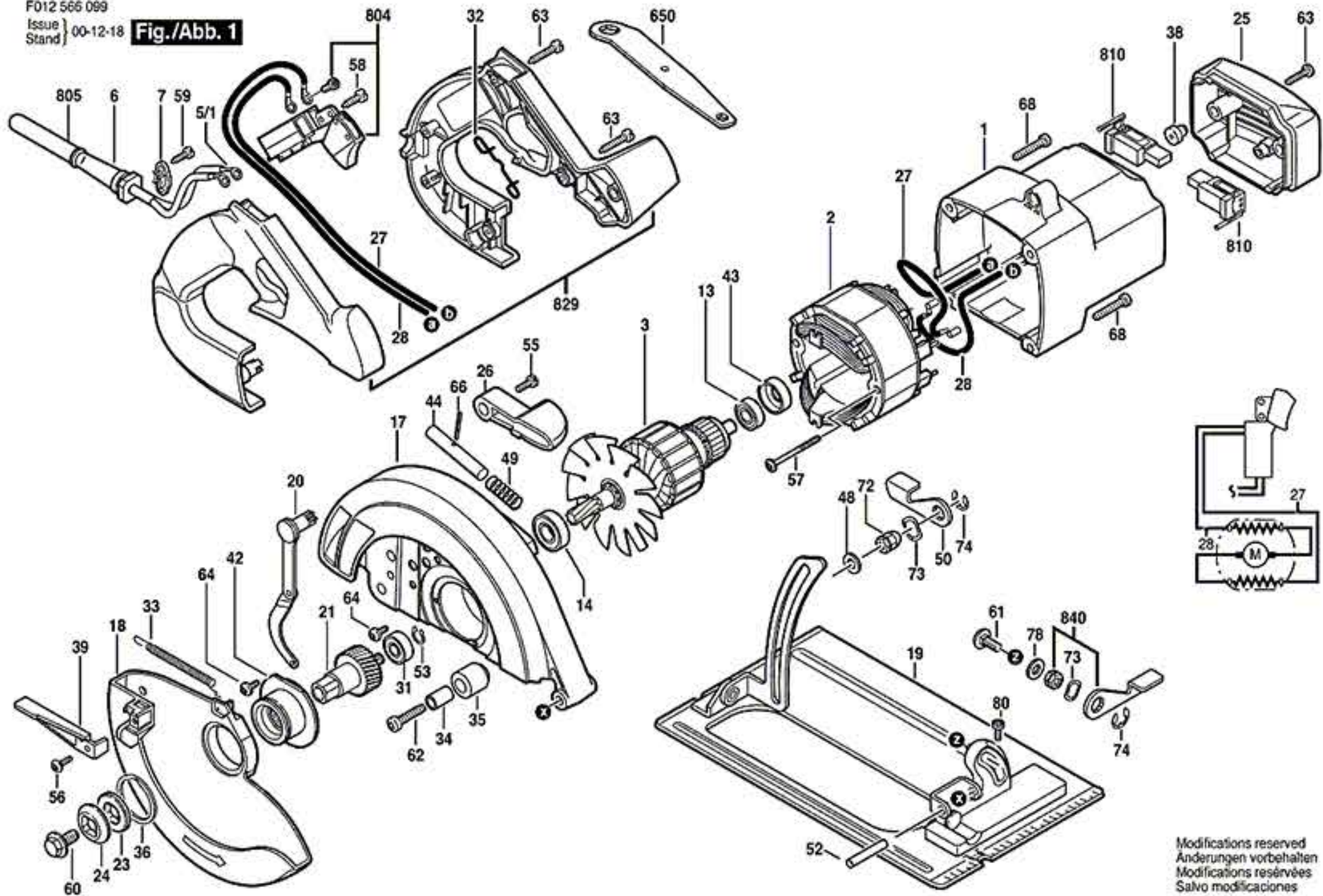

Modifications reserved  
Änderungen vorbehalten  
Modifications réservées  
Salvo modificaciones