

F012 570 001

Issue
Stand 03-12-03

Fig./Abb. 1

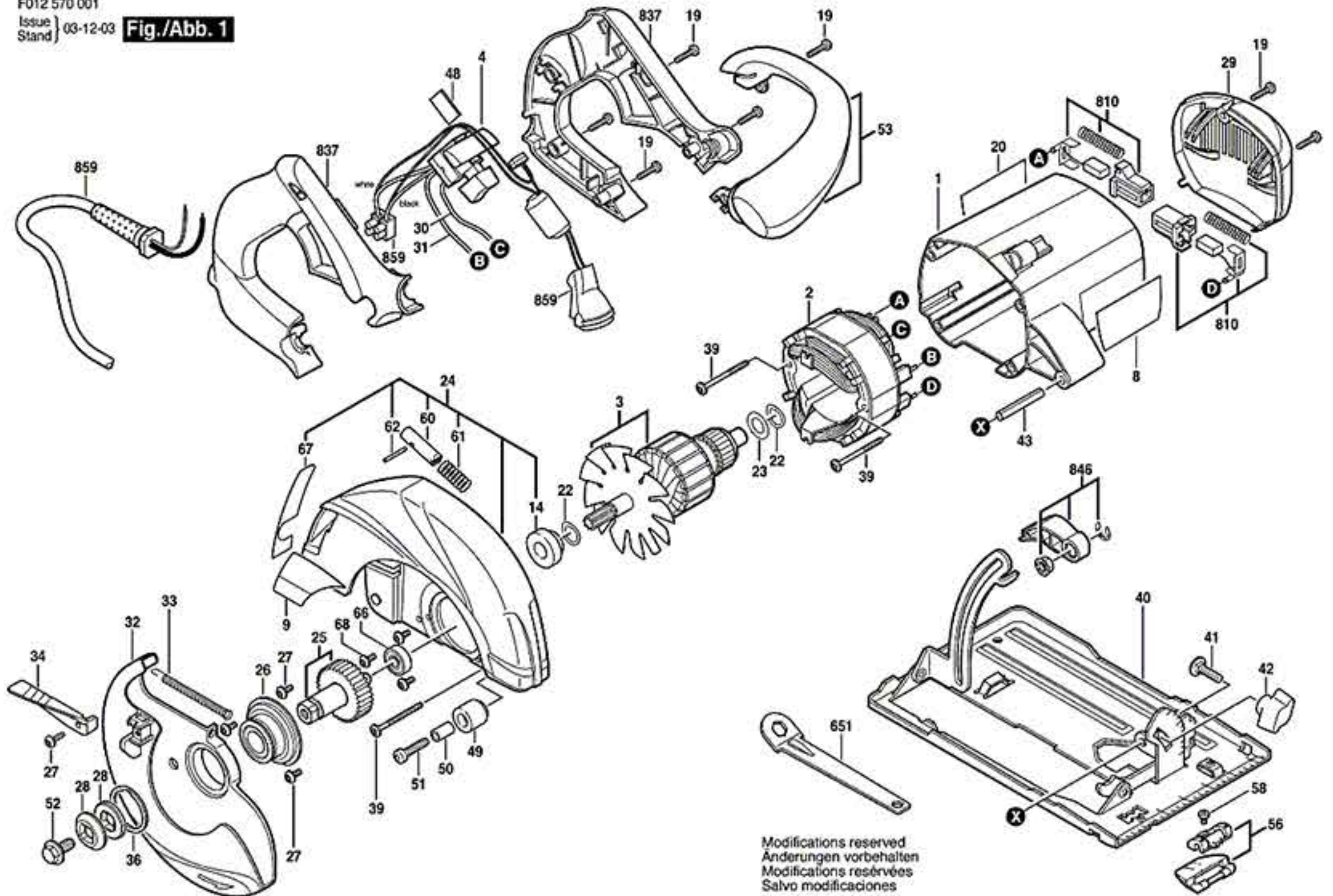

Modifications reserved
Änderungen vorbehalten
Modifications réservées
Salvo modificaciones