

F012 612 54A

Issue
Stand 00-09-11

Fig./Abb. 1

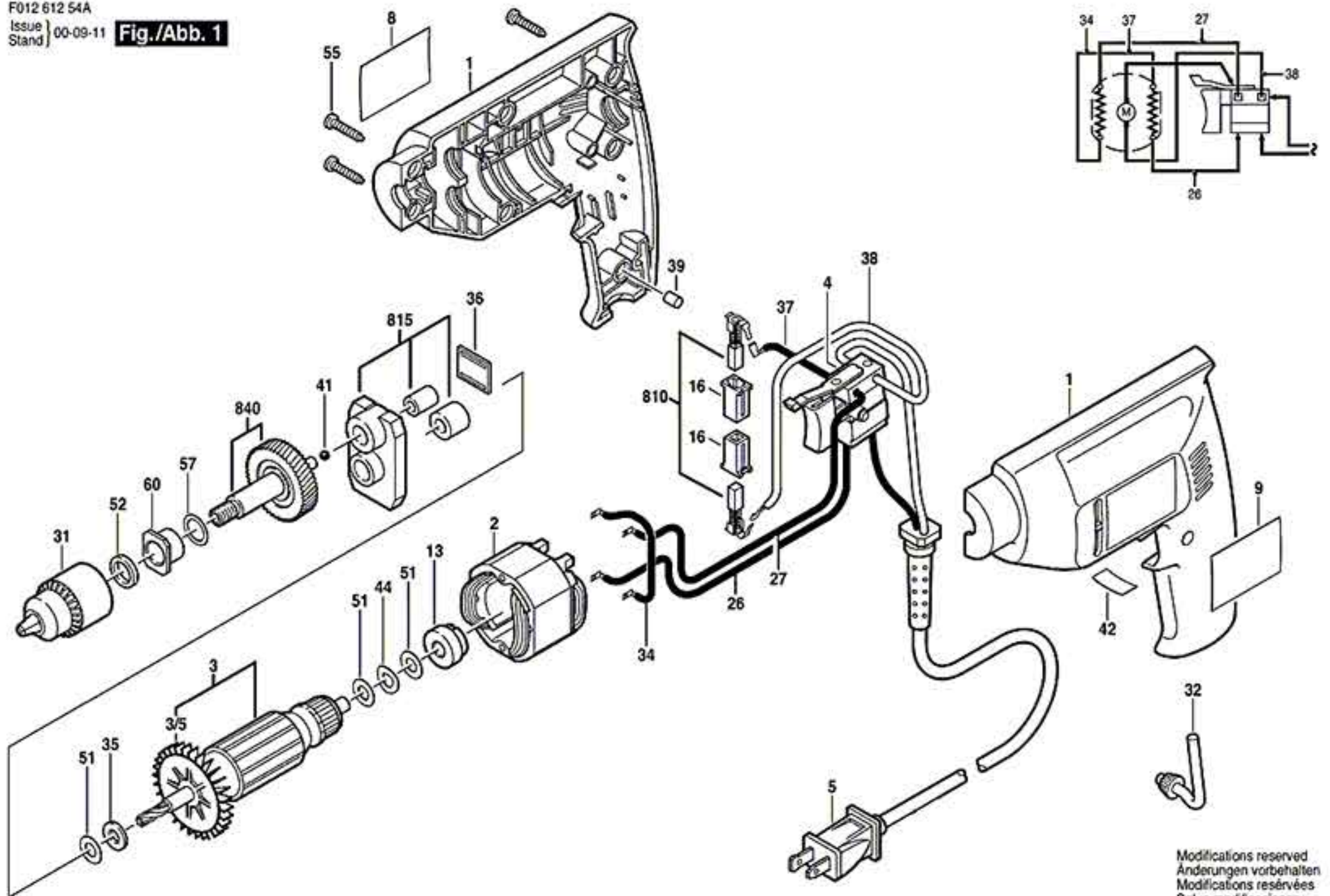

Modifications reserved
Änderungen vorbehalten
Modifications réservées
Salvo modificaciones