

F012 723 200

Issue
Stand } 08-07-17

Fig./Abb. 1

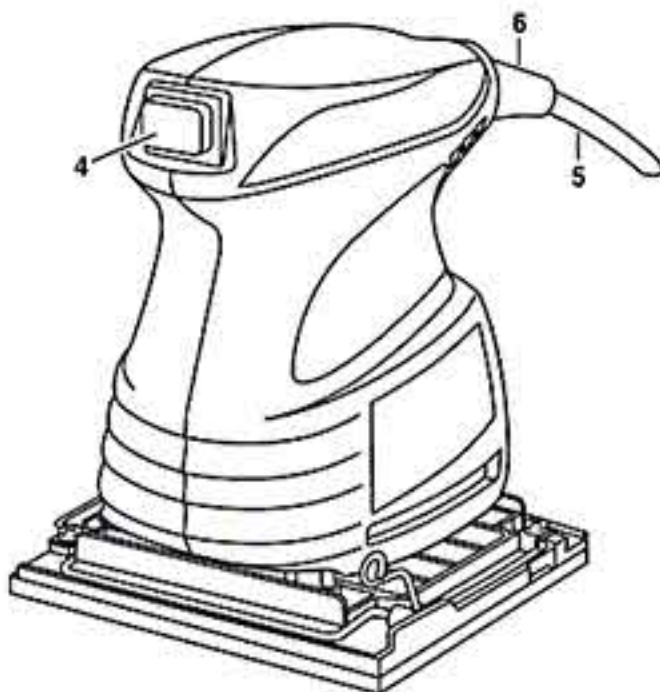

Modifications reserved
Änderungen vorbehalten
Modifications réservées
Salvo modificaciones