

3 601 D41 010

Issue } 10-10-12 **Fig./Abb. 1**
Stand }

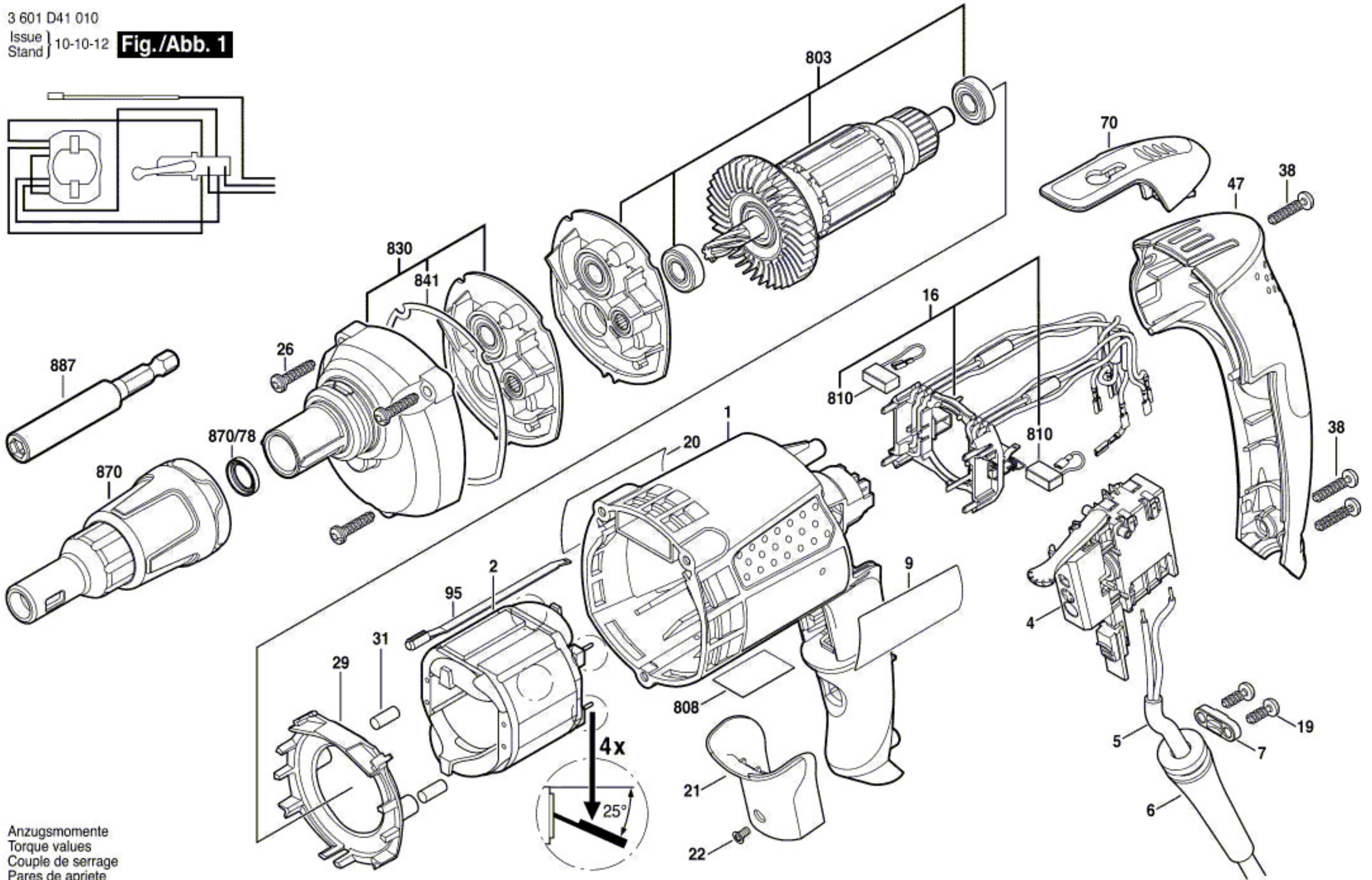

Anzugsmomente
Torque values
Couple de serrage
Pares de apriete
Pos. 19 = 1,5 Nm
22 = 1,0 Nm
26 = 2,0 Nm
38 = 2,0 Nm

Modifications reserved
Änderungen vorbehalten
Modifications reserves
Salvo modificaciones